

foc.us / v2

foc.us v2 and dock
instructions

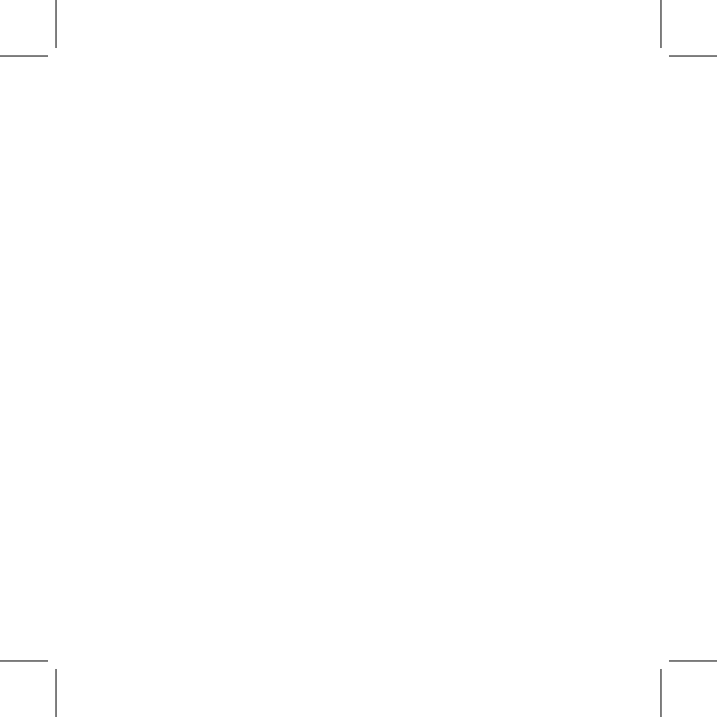

Contents

5	Welcome	22	Setup options
6	Warning	25	foc.us dock & software
8	What you need to understand before using foc.us	26	Intended use
11	What's in the box	27	Bluetooth® connection
13	Before starting	27	Troubleshooting
15	Getting started	28	Specifications
17	Calibrate your foc.us	28	Support
19	Programs	29	Glossary
21	Starting & Stopping a Session	30	FCC
		32	Warranty & Guarantee

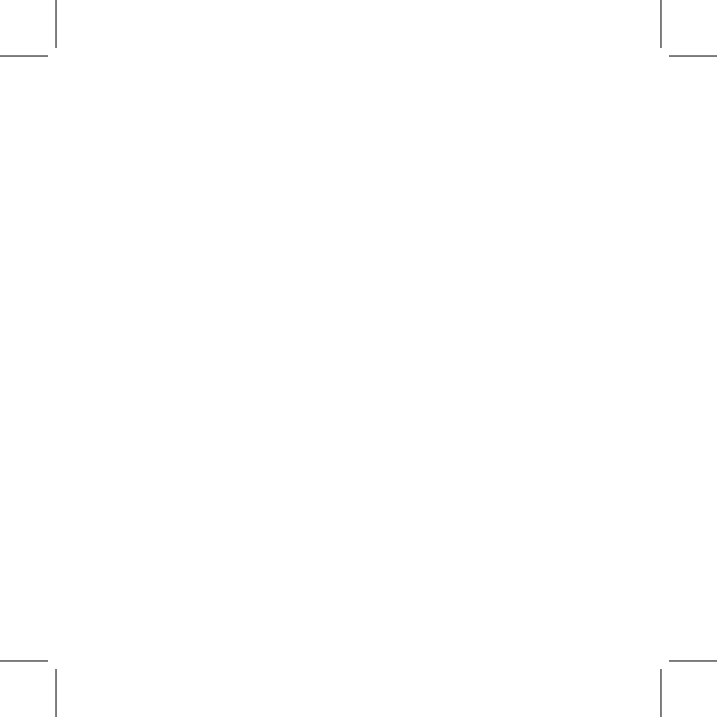

Welcome

The foc.us v2 is an advanced micro current signal generator.

Download the latest version of this manual from:

<http://www.foc.us/v2/downloads>

foc.us is designed to be used by healthy adults who do not suffer from epilepsy, brain or mental health conditions or have a metallic implant such as a skull plate, cochlear implant, pace-maker or others.



Warning

If you suffer from epilepsy, seizures, brain lesions, bipolar depression or severe heart disease you should not use the foc.us headset.



WARNING

If you experience short term negative effects with foc.us you should immediately stop using it.



BF APPLIED PART

This is not a toy and is not intended to be used by anyone under the age of 18 years old.

If using your own electrodes it is not recommended to create novel electrode placements.

Do not position the electrodes so that the current may pass through the brainstem.

Do not position the electrodes over cuts, grazes or damaged skin.

Allow at least 48 hours between usage.

Always use the electrodes with wet sponges.

Do not touch the metal electrodes as this can lead to burns.

What you need to understand before using foc.us

foc.us is designed to improve your mental gaming skills.

You are exciting and inhibiting sections of your pre-frontal cortex with an electric current.

Possible side effects include tingling sensations under the electrodes or on the scalp, visual artifacts, nausea, headaches and fatigue.

If you experience any of these you should stop using foc.us.

Repeated use may lead to skin irritation.

If you exceed the recommended durations you increase the risk of consolidating both

the excitatory and inhibitory processes. You may feel a tingling sensation, or a hot or cold sensation.

If this is uncomfortable or painful then you should stop session and remove the electrodes.

Redness may appear under electrodes after use which will disappear after a short time.

Foc.us should not be used during any activities other than seditary gaming. If you see white flashes, or phosphenes you should adjust the position of the headset on your head, pushing it further back away from your eyes.

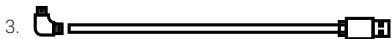
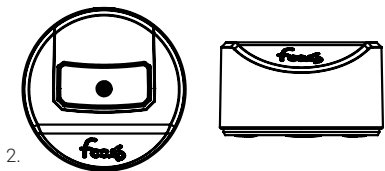
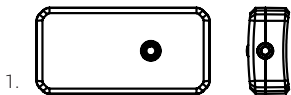

What's in the box

1. foc.us v2
2. foc.us dock
3. micro-usb cable for recharging
4. this instruction booklet

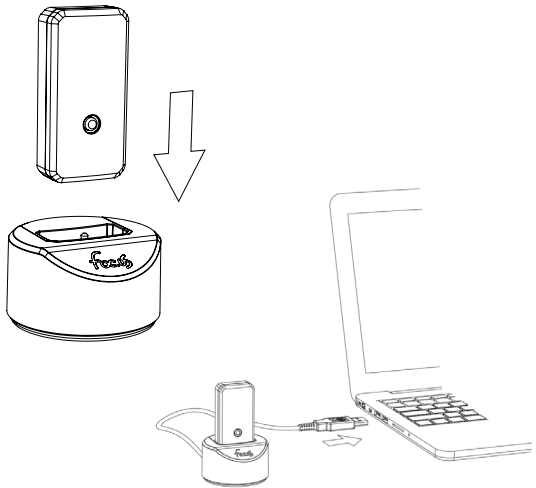

Before starting

Firmly push the v2 into the provided dock and connect the dock to a USB power supply to recharge.

Install the foc.us software and check for firmware updates.

<http://www.foc.us/v2/downloads>

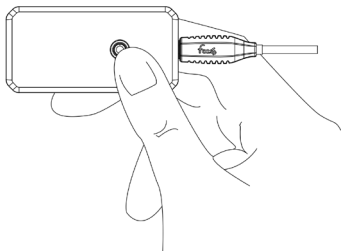
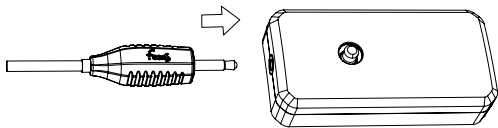

Getting starting

Wake the foc.us v2 by pressing the blue joystick and holding to turn on.

Connect a compatible “Made for foc.us” headset.

A list of compatible headsets can be found here:

www.foc.us/made-for-focus

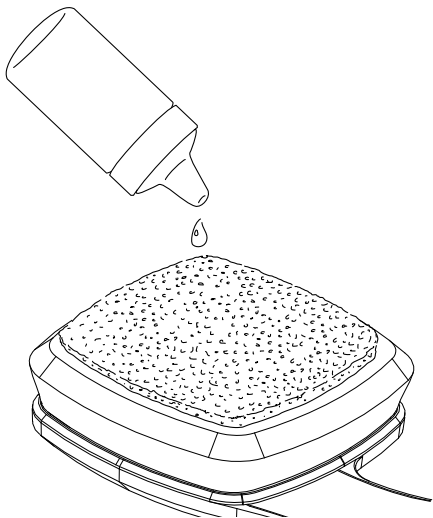

Calibrate your foc.us

The calibration function allows you to find a current level that is comfortable for you.

Start the calibrate function and follow the on-screen instructions.

You can recalibrate your foc.us at any time by entering the calibrate menu.

Ensure sponges are wet before use.

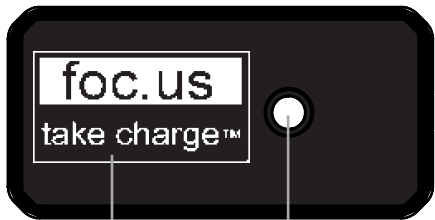

Screen

blue joystick



click to select

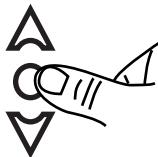

Programs

A program is a combination of settings used during a session.

Foc.us ships with two programs - Gamer and Endurance

You can create your own program with custom settings.

Your calibration settings will override any program settings.

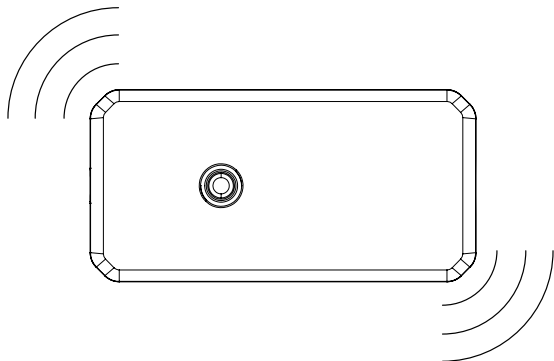

Starting & Stopping a Session

A program is a combination of settings used during a session.

Foc.us ships with two programs - Gamer and Endurance

You can create your own program with custom settings.

Your calibration settings will override any program settings.

Setup options

The setup menu contains options for language, security and communication settings.

Airplane mode - turns off bluetooth

PIN - the default PIN is 000000

Reset - reset your foc.us device to factory settings

Security - please set your foc.us device to lock to prevent un-authorized usage.

Language - if your language is not supported please contact help@foc.us
Session - foc.us+ session sharing settings

Warnings - it is not recommend to use your foc.us more than once every 48 hours.

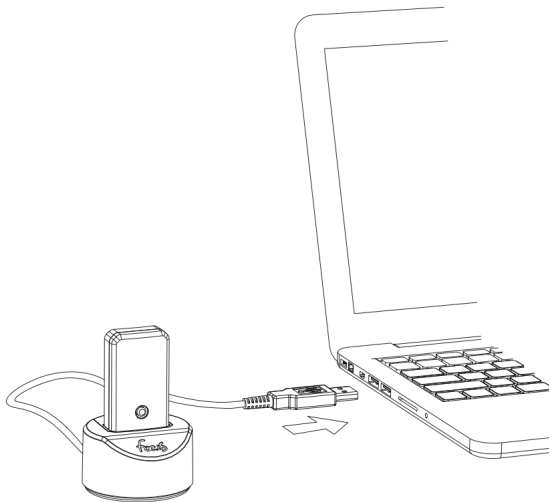

foc.us dock & software

The foc.us dock and software can be used to update the firmware of your v2.

It can also be used to sync your program and session data with foc.us+

Intended use

Use foc.us in accordance with the guidelines of the connected headset

WARNING: If you attach external electrodes, make sure you know what you are doing.

You have a responsibility to ensure they are not placed in positions that could be dangerous including but not limited to passing current through the brain stem.

Bluetooth® connection

foc.us can be controlled by bluetooth.

Approved apps can be found here:
<http://www.foc.us/v2/apps>

Troubleshooting

Problem

Cannot turn on

Solution

Ensure battery is charged
by placing in dock

Error mode

Battery will not
charge source.

Ensure sponges are wet

Check connection of
micro-usb to 5v power.

Specifications

Size: 56mm x 29mm x 14mm

Weight: 21g

Battery: 3.7V Li-Po 180mAh rechargeable

Max current: 2.05mA

Max voltage: 60V

Bluetooth: 4.0 bluetooth low energy GATT profile

FCC ID: 2AAH6NUFC9

Applied part (BF)

Support

More information is available on the website:

<http://help.foc.us/>

you can also email help@foc.us

Glossary

Activate	start the current flowing between the electrodes	A
Anode	positive electrode	A
Cathode	negative electrode	C N
Montage	the positioning of electrodes	tl
tDCS	transcranial Direct Current Stimulation	tl F S
tRNS	transcranial Random Noise Stimulation	
Phosphenes	visual artifacts	
Sedentary	sitting, not physically active	

Output Waveforms

Direct Current Stimulation

Constan current, max 2.0mA at 29K Ohms

Supports 1 anode and 1 cathode

Maximum DC output 58V, user
configurable

Qualified Accessoriess

foc.us EDGE

- 2 x 10cm 2 nickel plated electrodes - arm
and head placement

- use before training

foc.us GAMER

- 2 x 10cm 2 nickel plated electrodes - left
and right head placement

- use before video gaming

Cleaning and maintenance

Clean with a dry cloth

Battery should not be serviced. Opening the device voids the warranty.

Equipment providing body floating protection against electric shock.

Simultaneous connection of a patient to a h.f. surgical equipment may result in burns at the site of the stimulator electrodes and possible damage to the stimulator. Operation in close proximity to a shortwave or microwave therapy equipment may product instability.

Application of electrodes near the thorax may increase the risk of cardiac fibrillation.

FCC

FCC warning statement:

This device complies with Part 15 of the FCC Rules.

Operation is subject to the following two conditions:

(1) This device may not cause harmful interference, and

(2) This device must accept any interference received, including interference that may cause undesired operation.

This equipment complies with FCC radiation exposure limits set forth for an uncontrolled environment. End users must follow the specific operating instructions for satisfying RF exposure compliance.

This transmitter must not be co-located or operating in conjunction with any other antenna or transmitter.

Changes or modifications not expressly approved by the party responsible for compliance could void the user's authority to operate the equipment

Warranty & Guarantee

foc.us warrants the foc.us headset (the "Product"), and only the Product, against defects in materials and workmanship under normal use for a period of twenty four (24) months commencing on the date of original purchase by the original purchaser (the Warranty Period). This

warranty does not cover damage caused by misuse, accident, abuse, natural and/or external causes (i.e. fire, earthquake, flood, etc.), use other than as intended and described in the Product instruction manual, finishes, normal wear and tear, tampering, unreasonable use, service performed by unauthorised service agents, or loss or damage to the battery. foc.us does not warrant that the operation of the Product will be uninterrupted or error-free.

Limitation of remedies

Under this Limited Warranty, foc.us liability and customer's exclusive remedy under the foregoing paragraph will be limited to

replacement or repair of the Product by foc.us or its authorized service centers. A replacement Product or part assumes the remaining warranty of the original Product or Ninety (90) days from the date of replacement or repair, whichever is longer. To obtain warranty service contact help@foc.us

For your security, please return your Product with an insured carrier (e.g., FedEx, UPS, USPS Parcel Post) and retain your receipt. foc.us is not responsible for items damaged or lost in transit. Other than for the reason of hardware defects, the return freight cost responsibility belongs solely to the customer.

Limitation of damages

In no event will foc.us or any of its affiliated or subsidiary companies be responsible for any special, incidental, or consequential damages resulting from the use of this Product, or based on any breach of warranty, breach of contract, negligence, tort or any other legal theory.

Such damages may include without limitation, loss of savings or revenue; loss of profit; loss of use; the claims of third parties, including without limitation retailers; any cost of any substitute equipment or services.

Some states do not allow the exclusion or

limitation of incidental or consequential damages, so the above limitation may not apply to you.

The warranty gives specific legal rights, and you may have other legal rights, which vary from state to state or country to country.

This Limited Warranty is valid only in the the United States and Europe for Products sold in the United States and Europe.

Resellers, agents, or employees of foc.us are not authorized to make any modification, extension, or addition to this Limited Warranty.

take chargeTM

www.foc.us